

## Guide for ordering

① 75	①a -A	② 38	③ 0/6	④ P1-C	⑤ R	<b>ORDER CODE</b>
Plate Series	Cylinder	Plate Width	Function: 0 / 6 *Specify (F) if Fixed (e.g 0F/6)	Plate Profile and Edge detail	Handing	<b>75-A - 38 - 0/6 - P1-C - R</b>

### ① Lock & Plate Length Pairing

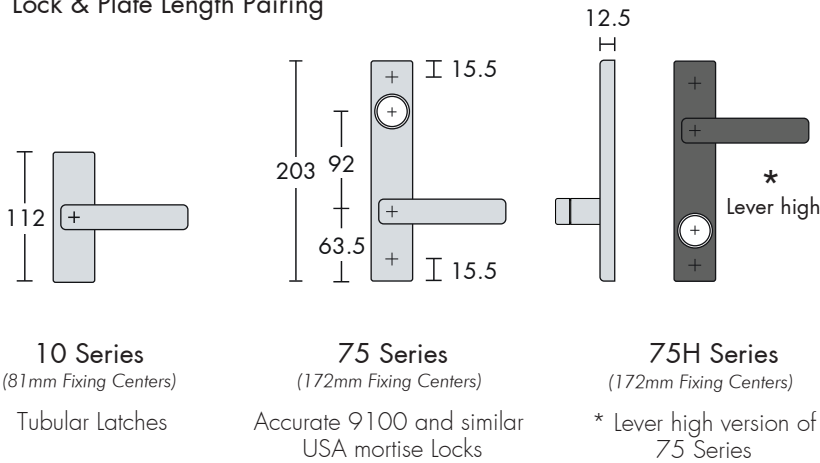

### ①a Cylinder Options

Specify suffix for required cylinder using the options below.

- A 1 ¼" Ø Cylinders (X = 32mm)
- B 1 ½" Ø Cylinders (X = 35mm)
- C 1 ¾" Ø Cylinders - Bevelled face

(-A / -B)

length 1/8" (4)

(-C)

length 1/16" (1.6)

### ② Plate Width Options

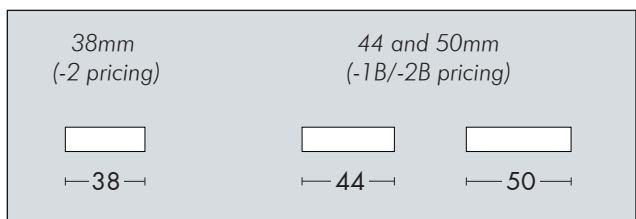

### ③ Select plate function (e.g order 0/6 where '0' = Passage outside & '6' = Cylinder inside)

Specify (F - Fixed) after the plate function if you required a fixed lever, or stipulate in the 'handing' field of the Order Form.

Outside / back fix plates concealed fixing					Inside / surface fix plates semi concealed fixing		
0	1	2	3	4	5	6	8
Passage	Cylinder	Recess E-Turn	E-Turn	Blank Cylinder	Passage	Cylinder	Thumb Turn

### ④ Select edge detail & profile

Select from list, Standard or 'VED' sheet

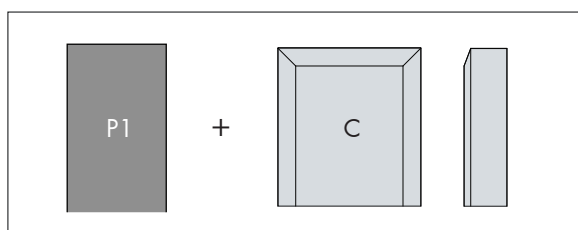

### ⑤ Specify handing

L for Left hand and R for Right hand.

Refer to the Chant handing sheet for more information

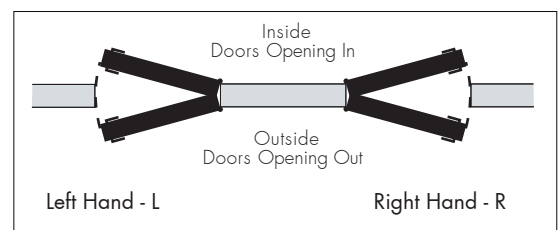

## Guide for ordering

① 76	② 38	③ 0/5	④ P1-C	⑤ R	<b>ORDER CODE</b>
Plate Series	Plate Width	Function: 0 / 5 *Specify (F) if Fixed (e.g 0F/5)	Plate Profile and Edge detail	Handing	<b>76 - 38 - 0/5 - P1 - C - R</b>

### ① Lock & Plate Length Pairing

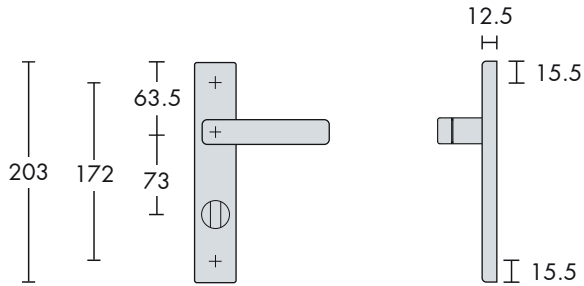

### 76 Series

Accurate 9800  
Series Interior Mortise Locks  
9825 Passage Latch,  
9839 Privacy Lock

### ② Plate Width Options

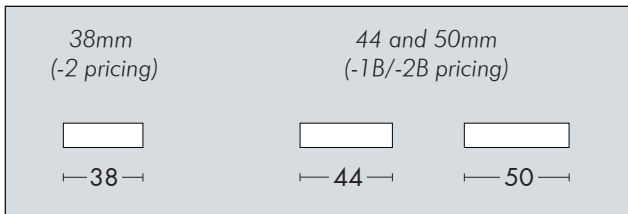

### ③ Select plate function (e.g order 0/5 where '0' = Passage outside & '5' = Passage inside)

Specify (F - Fixed) after the plate function if you required a fixed lever, or stipulate in the 'handing' field of the Order Form.

Outside / back fix plates concealed fixing			Inside / surface fix plates semi concealed fixing	
0	2	3	5	8
Passage	Recess E-Turn	E-Turn	Passage	Thumb Turn

### ④ Select edge detail & profile

Select from list, Standard or 'VED' sheet

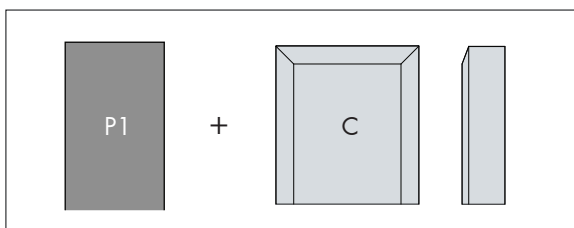

### ⑤ Specify handing

L for Left hand and R for Right hand.

Refer to the Chant handing sheet for more information

